

Intel Core i7 processor technology delivers ground-breaking performance

The search for the fastest Mini-PC has now come to an end. The Shuttle H7 5800P Complete System shines through not only due to the high-quality coating of its casing but it also leaves no doubt as to its superior performance. The Intel Core i7 processor, DDR3 memory, 2x Gigabit-network and many different connections set the benchmark here. Brand-new graphics cards guarantee a fluid display.

**Shuttle XPC
H7 5800P**



Feature Highlights

H7 chassis	<ul style="list-style-type: none"> Black aluminium chassis (glossy) Drive bays: 1x 5.25", 2x 3.5"
Chipset	<ul style="list-style-type: none"> Intel X58 Express + ICH10R
CPU	<ul style="list-style-type: none"> Intel® Core™ i7 Quad-Core Processor Socket 1366 Supports 4.8/6.4 GT/s QPI Vapor Chamber ICEvo Heatpipe cooling
Graphics	<ul style="list-style-type: none"> PEG Graphics Card from ATI or NVIDIA e.g. NVIDIA GeForce GTX 295 1792MB
Memory	<ul style="list-style-type: none"> Up to 4GB DDR3-1066/1333 Supports Triple Channel + 1
Drives	<ul style="list-style-type: none"> Serial ATA hard disk drive up to 2 TB Optional 3.5" Card Reader DVD writer or Blu-ray Combo/Writer
Other connectors	<ul style="list-style-type: none"> 7.1-ch HD-audio, SPDIF output Dual GigaBit LAN (supports Teaming) USB 2.0 (2x front, 6x rear), 6x eSATA
Power supply	<ul style="list-style-type: none"> 500 Watt mini power supply 80 PLUS Bronze compliant
Application	<ul style="list-style-type: none"> Performance



Note: optical drive sold separately. Images for illustration purposes only.

Shuttle XPC H7 5800P – Special Product Features

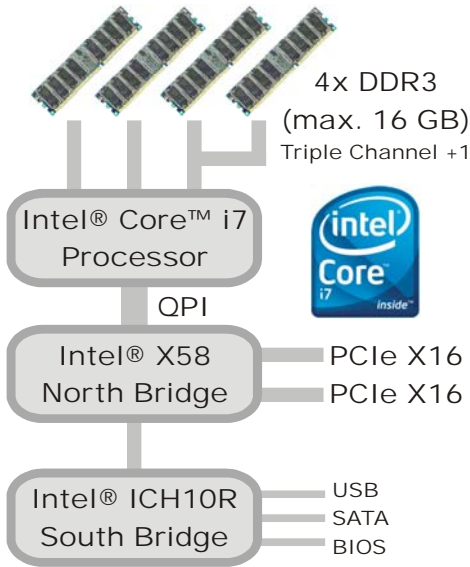

Based on new Intel Nahalem architecture

The Shuttle XPC H7 5800P is based on the new core microarchitecture, codenamed Nehalem, which brings some major changes not only to the the processor architecture but also the system architecture. These are most significant changes:

- The memory controller has moved from the chipset to the processor and features a triple channel DDR3 interface.
- The Intel® QuickPath Interconnect (QPI) replaces the legacy front side bus between processor and chipset.

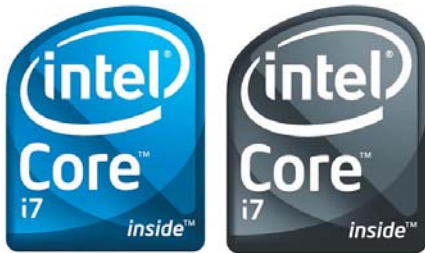

With Intel Core i7 processor

The Shuttle XPC H7 5800P is the first Shuttle XPC with the new Socket 1366 and is equipped with an Intel® Core™ i7 processor. This is the first Intel processors which come with a native quad-core design, where all four cores sit on the same piece of silicon which share a massive 8MB level 3 cache. In addition, each core supports Hyper-threading which enables this processors process eight threads simultaneously, making it even more massively parallel and powerful than the current Core 2 Quad CPUs.

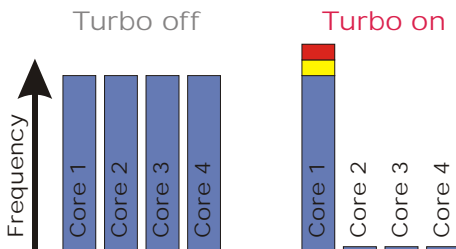

Built-in overclocking "Turbo" mode

Originally introduced on mobile Penryn, Turbo mode simply increases the operating frequency of the processor if conditions are cool enough for the CPU to run at the higher frequency. Each Nehalem can run its four cores at up to 133MHz higher than the stock frequency (e.g. 3.33GHz in the case of the 3.2GHz 965 model), or if only one core is active then it can run at up to 266MHz higher than stock (3.46GHz up from 3.2GHz). Benchmarks show an increase of the overall performance by 2% to 7% if Turbo mode is enabled in the BIOS setup.



Integrated Cooling Evolution (I.C.Evo)

Shuttle's XPCs offer the power of a desktop PC in a form factor one-third the size. In order to ensure proper airflow inside a smaller unit, more advanced cooling technologies have been developed and implemented in the Shuttle XPC. Shuttle's industry-leading I.C.Evo heatpipe technology delivers efficient cooling and is exceptionally quiet.

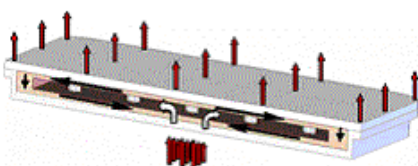

New Vapor Chamber + Heatpipe Technology

The vaporizing chamber is utilized as cooler base witch is similar to the thermal tubes operating principle. The thermal resistance of vapor chamber is twice lower than in usual base. At low fan speed this technology reduces the CPU temperature by 5~7°C.

PCI EXPRESS



PCI-Express V2.0 for high-performance graphics cards

The Shuttle XPC H7 5800P is equipped with one PCI-Express x16 Version 2.0 slot delivering a bandwidth of up to 16GB/s, twice the speed of PCI-E 1.0, thus providing plenty of potential for the newest graphics cards. It is downward compatible, allowing use for most of the present graphics cards as well.

Supports large dualslot graphics cards

The Shuttle XPC H7 5800P supports large dual-slot graphics cards like ATI Radeon HD4870 or NVIDIA Geforce GTX295 which occupy two slots. Please note, that in this case you cannot use the second slot for another expansion card.



500W power supply with 80 PLUS BRONZE logo

The Shuttle XPC H7 5800P is equipped with a rock stable 500W power supply which has been tested with the latest graphics cards and powerful Core i7 processors. Its 80 Plus Bronze logo indicates that it provides more than 82/85/82% energy efficiency at 20/50/100% of rated load which reduces energy consumption and increases the computers reliability.



New Era of All-Solid Capacitor Shuttle Mainboards

By using all-solid capacitors Shuttle mainboards provide industry leading stability, reliability and longevity for PC gaming and entertainment systems. The average lifespan for a solid capacitor is more than six times greater than the more common and less expensive electrolytic capacitors.



External Serial ATA ports on front and back panel

In addition to the two eSATA ports at the back panel, the SX58H7 also comes with one eSATA at the front panel for plugging in high-speed external hard-drives. The eSATA interface is up to three times faster than the USB 2.0 standard.



Dual eSATA with External Power

The back panel provides two external Serial ATA ports and a power port. The included cables make it a snap to connect two external hard drive to your XPC. The Serial ATA interface is up to six times faster than USB 2.0/Firewire.



Dual Gigabit LAN with Teaming Support

This XPC features even two high-speed Gigabit LAN ports. The teaming function allows you to group both available network adapters together to function as a single adapter - a method of creating a virtual LAN. The benefit of this approach is that it enables load balancing and failover.

Shuttle XPC H7 5800P Specifications

<i>Application</i>	Recommended range of application: Performance
<i>Basis</i>	System based on: the Shuttle XPC Barebone SX58H7
<i>Operating System</i>	Microsoft Windows Vista (various versions available) 9 languages available: German, English, French, Dutch, Italian, Spanish, Swedish, Finnish, Danish
<i>Chassis</i>	H7-type aluminum chassis, color: black Front panel with glossy finish and painted, shining top cover, stealthed drive doors Dimensions: 32.5 x 20.8 x 18.9 cm (LWH), 12.8 litres
<i>Processor</i>	Socket 1366 with Intel® Core™ i7 Quad-Core processor The memory is directly connected to the processor Supports DDR3-1066/1333 (3+1 channel) Integrierter 8MB L3-Cache All cores, the memory controller and all cache are on a single die 45nm process technology Built-in overclocking "Turbo" mode The previous Front Side Bus (FSB) by the new QPI (QuickPath Interconnect) which features up to 6.4GT/s (3.2GHz) and a maximum transfer rate of 25.6GB/s. New heatpipe processor cooling
<i>I.C.Evo</i>	Shuttle Integrated Cooling Evolution (I.C.Evo) New Vapor Chamber + Heatpipe Technology The vaporizing chamber is utilized as cooler base witch is similar to the thermal tubes operating principle. The thermal resistance of vapor chamber is twice lower than in usual base. At low fan speed this technology reduces the CPU temperature by 5~7°C.
<i>OASIS heat pipe</i>	OASIS Cooling Technology: additional fanless heat-pipe design covering the MOSFET modules (VRM), north- and southbridge.
<i>Chipset & components</i>	Chipset: Intel X58 Express (codenamed Tylersburg) + ICH10R (I/O Controller Hub) Solid Capacitors for excellent heat resistance for enhanced system durability
<i>Memory</i>	Up to 4GB DDR3-1066/1333 modules in Dual or Triple Channel mode
<i>Graphics card</i>	PCI Express x16 graphics card from ATI or NVIDIA Outputs: Sub-D (analog)*, DVI-I (digital/analog) and TV (S-Video/Composite) *) Sub-D connector may be provided by adapter optionally
<i>Hard disk</i>	One Serial ATA hard disks, supports 3 Gbit/s, up to 2TB capacity
<i>Optical drive</i>	DVD Writer or optional Blu-ray Combo/Writer

<i>Card reader</i>	Optional: 3.5" multi-format card reader (USB 2.0)
<i>Empty slot</i>	1x PCI-Express x16 (if only one single-slot graphics card is chosen)
<i>8-ch Audio</i>	7.1 channel High Definition Audio with Realtek ALC888 codec analog: line-out (8-ch), line-in, microphone, CD-in, AUX digital: optical S/PDIF-out
<i>Dual LAN</i>	Dual Gigabit LAN Controller 2x RJ45 connectors supports Teaming-Mode*) Realtek RTL8111C Ethernet network controller IEEE 802.3u 1000Base-T compliant Supports 10 / 100 / 1.000 MBit/s operation Supports Wake-on-LAN
<i>Front panel</i>	Microphone Headphone (Line-out) 2x USB 2.0 External Serial ATA Hotplug (eSATA) Power button Reset button Power indicator (blue LED) HDD indicator (orange LED)
<i>Back panel</i>	6x USB 2.0 2x GigaBit LAN (RJ45) 2x External Serial ATA Hotplug (eSATA) Power connector for two eSATA hard disks (incl. cable) 8-ch Audio line-out (2x rear/front, bass/center, surround/back) Audio Line-in Digital Audio: optical S/PDIF output Clear CMOS button
<i>Optional Accessories</i>	Wireless LAN Antenna (PN20) PS/2 Mouse & Keyboard connectors (PS10)
<i>Power supply</i>	500 Watt mini PSU, AC input voltage: 100~240V 80PLUS Bronze certified (>82/85/82% energy efficiency at 20/50/100% load) Active PFC circuit (Power Factor Correction)
<i>Further configuration options</i>	It is possible to modify certain components of this configuration. Please refer to the "Shuttle Systems Configurator".
<i>Warranty</i>	Warranty: 24 Months Pick-Up-And-Return Service

***) Teaming Mode**

The teaming function allows you to group both available network adapters together to function as a single adapter - a method of creating a virtual LAN. The benefit of this approach is that it enables load balancing and failover.

Shuttle XPC H7 5800P – Connectors and Components

Front Panel

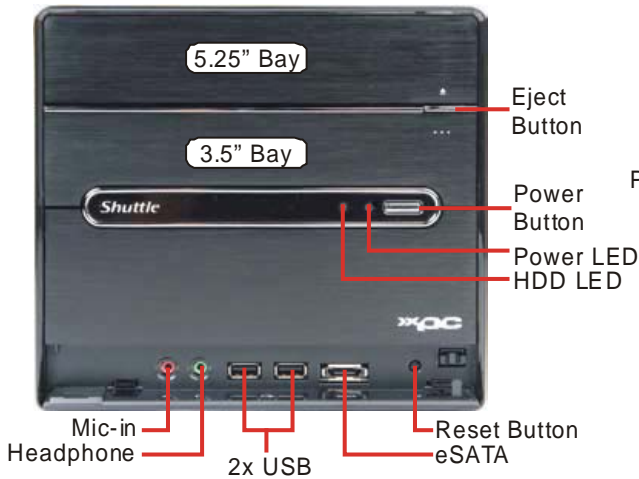

Back Panel

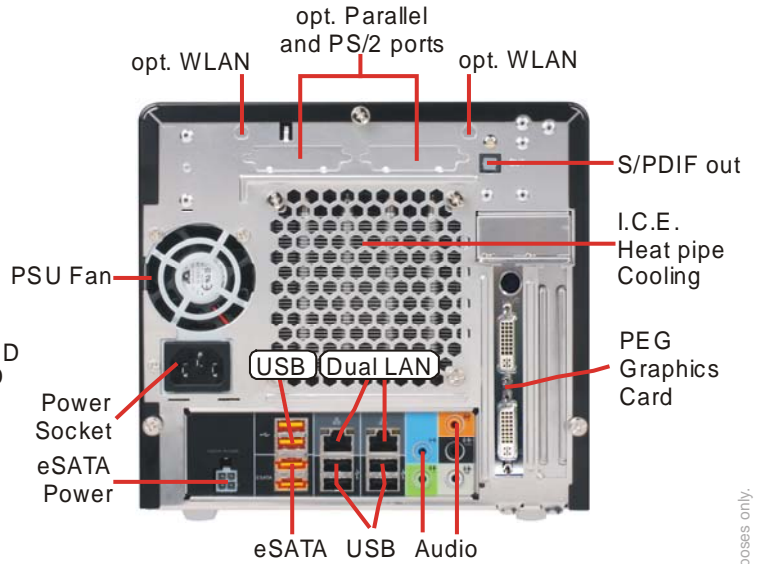

Mainboard

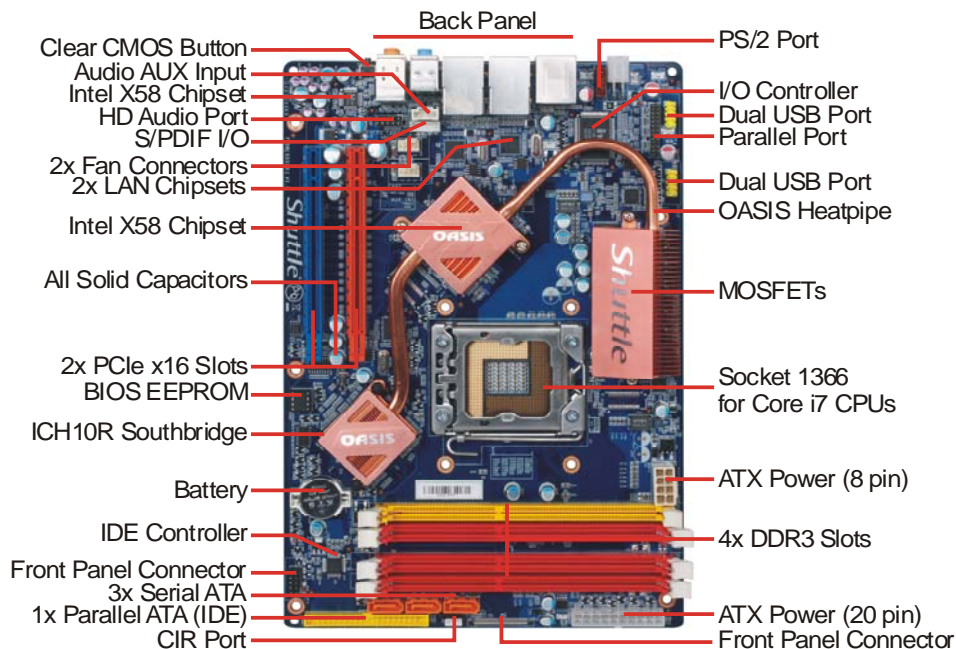

© 2009 by Shuttle Computer Handels GmbH (Germany). All Information subject to change without prior notice. Pictures for illustration purposes only.