

Box-PC Barebone BPCWL02-i3

Intel Core i3-8145UE Processor

FANLESS SHUTTLE BOX-PC

WITH INTEL CORE ULV PROCESSOR IN A ROBUST CHASSIS

Shuttle's new generation BPCWL02 IPC Series in a ruggedized box design for high durability consists of compact fanless IPC systems with modular expansion for wide-range industrial applications.



Rear View

Images for illustration only

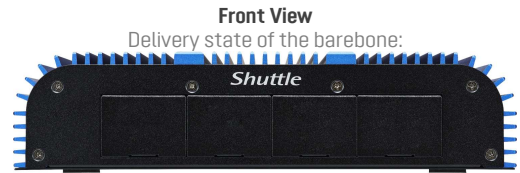

Front View
Delivery state of the barebone:



Example illustration with optional connections:

Caution: Only suitably trained persons may open the barebone and install optional components!



ROBUST CHASSIS

- Fanless cooling system
- Robust aluminium/steel chassis
- Dimensions (LWH): 16.9 x 24.5 x 5.7 cm (2.7 L)
- Net weight: 2.85 kg
- IP Rating: IP30
- Mounting options: VESA, Ear mount and DIN Rail

OPERATING TEMPERATURE RANGE [1]

- **Standard:** 0 – +40 °C
- **Industry:** -20 – +60 °C (Optional)
- Operating humidity: 20 – 80% (non-condensing)

OPERATING SYSTEM SUPPORT

- An operating system is not included.
- Supports Windows 10/11 and Linux (64-bit)

PROCESSOR

- Intel Core i3-8145UE Gen. 8 "Whiskey Lake" ULV processor, 15 W TDP
- Integrated Intel UHD 620 graphics

RAM/SSD SUPPORT

- 2x 260-pin SO-DIMM slot
- Supports up to 2x 32 GB DDR4-2400
- M.2-2280M slot supports one SSD card (PCIe X4 NVMe or SATA)

BACK PANEL CONNECTORS

- HDMI 1.4
- 4x USB 3.2 Gen 1
- Dual Gigabit LAN
- COM Port RS232
- Mic-in and Line-out
- DC-input (2.5/5.5 mm)
- Power Button

OTHER FEATURES

- Hardware TPM v2.0 Infineon SLB9670VQ2 onboard

OPTIONAL FRONT PANEL CONNECTORS

- Graphics ports: HDMI 1.4, DVI-I, DisplayPort 1.2 or VGA
- Up to three additional COM ports
- Up to 8 (16) additional USB 2.0 ports
- Up to four additional 2.5 Gbps LAN ports
- Up to four Digital I/O expansion kits (each with 4x Input and 4x Output)
- Input for car ignition lock enables delayed on/off switching of the BoxPC

LTE/WLAN OPTIONS

- LTE/4G kit with 2 antennas (LTE card and Nano-SIM not included)
- WLAN kit with 2 antennas Wi-Fi 6 (ax)

POWER SUPPLY

- DC-Input: 19V, optional wide range DC-input 9~36V
- External 90W/19V power adapter



Versions of the BPCWL02 series

Category	Product Name	Intel ULV Processor	AMT/vPRO Support	Operating-temp.	Operating System	RAM	M.2 SSD	Pre-installed I/O Expansion Kits	Bar Code
Barebone	BPCWL02-i3	Core i3-8145UE	—	0...40 °C	—	—	—	—	887993005003
	BPCWL02-i5	Core i5-8365UE	Yes	0...40 °C	—	—	—	—	887993005010
	BPCWL02-i7	Core i7-8665UE	Yes	0...40 °C	—	—	—	—	887993005607
System Fix	BPCWL02-i3XA	Core i3-8145UE	—	0...40 °C	—	4 GB	120 GB	Dual COM, 4x USB 2.0, VGA, DC-in: 9-36V	4046047103652
	BPCWL02-i5WA	Core i5-8365UE	Yes	0...40 °C	Win10 IoT	8 GB	250 GB	Dual COM, 4x USB, VGA, DC-in: 9-36V	4046047103669
System BTO	Optionally choose an individual configuration for a complete system according to your wishes (Built-to-order)								

[1] For the extended operating temperature range (-20 to +60°C) a special 150W power supply (Order No. PA1501) and industrial-grade RAM/SSD components with an operating temperature range of -40 ... +85 °C are required.

Front and Back Panel

Front panel

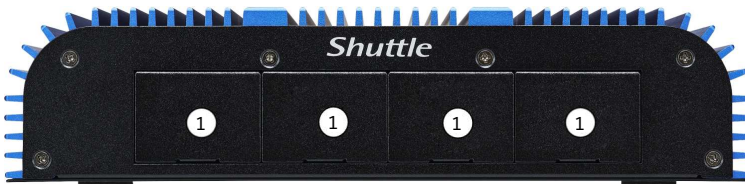

Back panel



1. The front panel has four sections to support optional I/O expansion kits

Example for optional I/O ports:



2. Audio Line Out (Headphones output)
3. Microphone input
4. Gigabit LAN port (Intel i211, black)
5. Gigabit LAN port (Intel i219LM, yellow)
6. 4x USB 3.2 Gen 1 Type A port
7. HDMI 1.4 port
8. COM port (RS232)
9. DC-in connector for power adapter
10. Power button
11. 2x WLAN antenna (optional)

Inside View

Front Panel

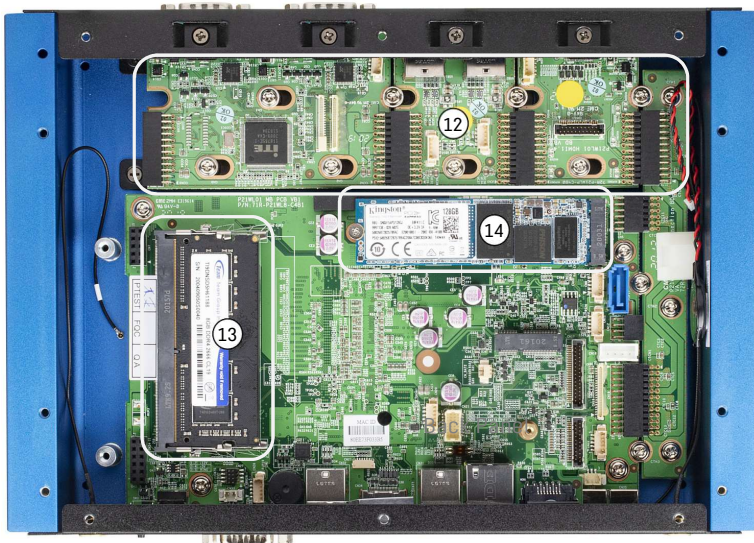

12. Area for optional daughter boards
13. 2x SO-DIMM slot supports DDR4-2400
14. M.2-2280/2260 M slot for SSD card (NVMe/SATA)
15. Screw threads for VESA mount (75x75 mm)

The picture shows optional components (12, 13 and 14) that are not included in the barebone product.

Back Panel

Dimensions

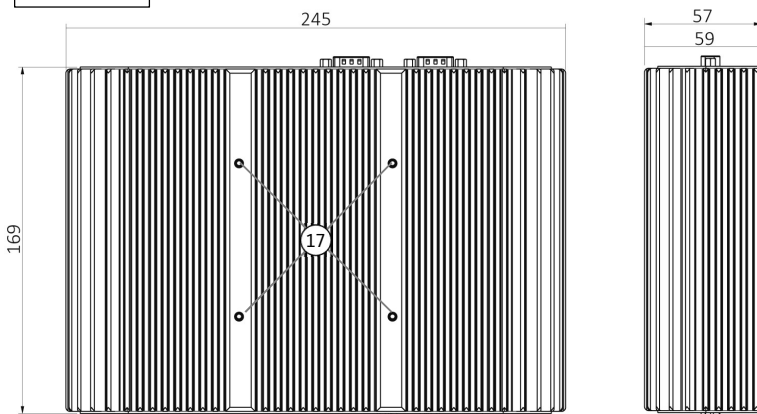

Dimensions:

Width: 245 mm (without optional ear mount)
 Depth: 169 mm
 Height: 57 mm (59 mm including feet)

Barebone models and optional accessories

Caution: Only suitably trained persons may open the barebone and install optional components

<p>Processor</p>	<p>The processor is permanently soldered onto the mainboard. The desired processor is selected with the barebone version:</p> <table border="1" data-bbox="371 360 1305 495"> <thead> <tr> <th>Shuttle BoxPC Barebone Modell</th> <th>Built-in Processor</th> <th>Cores</th> <th>Threads</th> <th>Takt / GHz</th> <th>Cache</th> <th>AMT/vPro</th> </tr> </thead> <tbody> <tr> <td>BPCWL02-i3</td> <td>Intel Core i3-8145UE</td> <td>2</td> <td>4</td> <td>2.2 – 3.9</td> <td>4 MB</td> <td>–</td> </tr> <tr> <td>BPCWL02-i5</td> <td>Intel Core i5-8365UE</td> <td>4</td> <td>8</td> <td>1.6 – 4.1</td> <td>6 MB</td> <td>Supported</td> </tr> <tr> <td>BPCWL02-i7</td> <td>Intel Core i7-8665UE</td> <td>4</td> <td>8</td> <td>1.7 – 4.4</td> <td>8 MB</td> <td>Supported</td> </tr> </tbody> </table>	Shuttle BoxPC Barebone Modell	Built-in Processor	Cores	Threads	Takt / GHz	Cache	AMT/vPro	BPCWL02-i3	Intel Core i3-8145UE	2	4	2.2 – 3.9	4 MB	–	BPCWL02-i5	Intel Core i5-8365UE	4	8	1.6 – 4.1	6 MB	Supported	BPCWL02-i7	Intel Core i7-8665UE	4	8	1.7 – 4.4	8 MB	Supported
Shuttle BoxPC Barebone Modell	Built-in Processor	Cores	Threads	Takt / GHz	Cache	AMT/vPro																							
BPCWL02-i3	Intel Core i3-8145UE	2	4	2.2 – 3.9	4 MB	–																							
BPCWL02-i5	Intel Core i5-8365UE	4	8	1.6 – 4.1	6 MB	Supported																							
BPCWL02-i7	Intel Core i7-8665UE	4	8	1.7 – 4.4	8 MB	Supported																							
<p>Storage</p>	<p>Install memory components into the barebone system that you purchase from a specialized dealer:</p> <ol style="list-style-type: none"> up to 2x 32 GB DDR4 SO-DIMM (DDR4-2400 or higher) one M.2-2280 SSD card with PCIe/NVMe or SATA interface 																												
<p>Operating-temperature</p>	<p>The permissible operating temperature range with standard components is 0 ... +40 °C.</p> <p>The extended temperature range of –20 ... +60°C is only permissible with the following components:</p> <ol style="list-style-type: none"> special 150W power adapter with order no. PA1501 industrial-grade RAM/SSD components with an operating temperature range of –40 ... +85 °C 																												
<p>Mounting</p>	<p>The BoxPC can be placed horizontally on its rubber feed or can be mounted in the following three ways:</p> <table border="1" data-bbox="371 965 927 1077"> <thead> <tr> <th>Mounting Method</th> <th>Accessory Product</th> </tr> </thead> <tbody> <tr> <td>VESA-mount, 75x75 mm</td> <td>from specialised dealers</td> </tr> <tr> <td>Ear mount brackets (on both sides)</td> <td>MRS01</td> </tr> <tr> <td>Clip for DIN Rail mounting</td> <td>MDR01</td> </tr> </tbody> </table> <p>See explanations on the next page</p>	Mounting Method	Accessory Product	VESA-mount, 75x75 mm	from specialised dealers	Ear mount brackets (on both sides)	MRS01	Clip for DIN Rail mounting	MDR01																				
Mounting Method	Accessory Product																												
VESA-mount, 75x75 mm	from specialised dealers																												
Ear mount brackets (on both sides)	MRS01																												
Clip for DIN Rail mounting	MDR01																												
<p>WLAN</p>	<p>Perforations provided on the back panel of the BoxPC for mounting the WLAN antennas.</p> <table border="1" data-bbox="371 1189 927 1301"> <thead> <tr> <th>Description</th> <th>Accessory Product</th> </tr> </thead> <tbody> <tr> <td>2x external antenna 2x antenna cable, 2x thermal pad</td> <td>CWL01</td> </tr> <tr> <td>M.2-2230 WLAN card</td> <td>not included</td> </tr> </tbody> </table>	Description	Accessory Product	2x external antenna 2x antenna cable, 2x thermal pad	CWL01	M.2-2230 WLAN card	not included																						
Description	Accessory Product																												
2x external antenna 2x antenna cable, 2x thermal pad	CWL01																												
M.2-2230 WLAN card	not included																												
<p>Extended Voltage Range</p>	<p>The DC input connector (2.5 / 5.5 mm) supports 19V input voltage and a suitable 90W power adapter is included in the scope of delivery.</p> <p>To be able to use other power sources, the input voltage range can be extended to 9 ... 36 V DC by adding the optional voltage regulator modul with order no. VOL01.</p>																												
<p>Upgrade of a LAN port</p>	<p>The black LAN port on the back panel with max. 1 Gbps speed can optionally be upgraded to 2.5 Gbps speed (Intel i226 chip) with the accessory IDL11.</p>																												

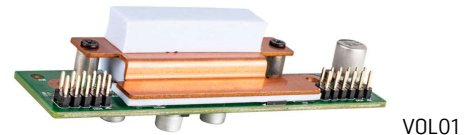
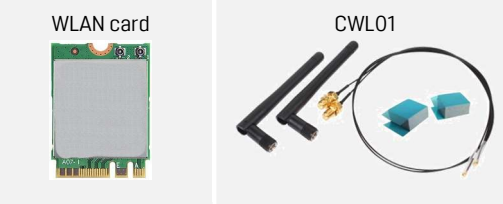
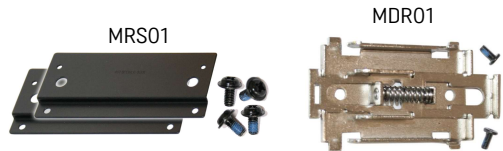
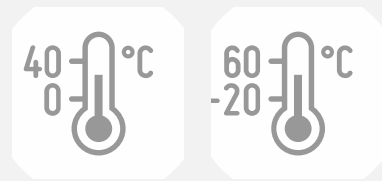
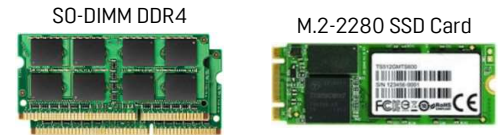

Optional I/O Ports Front Panel







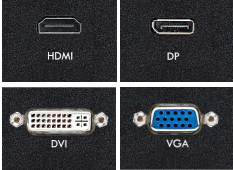

Expansion concept with optional daughter boards

The front panel is subdivided into four sections to support optional expansion kits in order to add I/O ports.

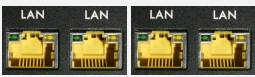

Every optional expansion kit is required to start from Section 1 (on the right) with the second kit occupying Section 2 etc. Some kits occupy two sections.



Expansion options:

PORT	ORDER No.	IMAGE	OCCUPIED SECTIONS	MAXIMUM KITS	NOTE
HDMI 1.4 DP 1.2 DVI-I VGA	DHD01 DDP01 DDV01 DVG01		1	1	1) One HDMI 1.4 port is in the back panel (fix). 2) One of these graphics ports can be added: HDMI 1.4, DisplayPort 1.2, DVI-I or VGA. 3) In addition, a VGA port can be installed, but this is not Plug&Play-capable.
4x USB 2.0	USB01		1	2 (4)	USB hub device (USB 2.0 ports allow up to 500mA/2.5W power output, but if only low power devices like mouse/keyboard are connected, then up to 4 USB kits can be used)
Single COM	CRS01		1	1	Supports RS232 only (passive cable adapter)
Dual COM	CSD01		2	1	Supports RS232/RS422/RS485 (with additional I/O controller chip)
LTE/4G Kit with 2 antennas	LTE01		2	1	Not included: M.2 LTE/4G card and Nano SIM card Compatible with e.g. Huawei ME906S, Sierra EM7455, Quectel EM06E etc.
4x LAN ports with 2.5 Gbps	IDL01		2	1	In addition to the existing 2x 1G LAN ports you can add four LAN ports with 2.5G speed <u>Note:</u> then only M.2 SSD cards with SATA interface are supported (no more PCIe/NVMe)
Dig. I/O-Kit 4x In / 4x Out	DI011		1	4	up to four Digital I/O expansion kits each with 4x Input and 4x Output
Input for car ignition lock	DI001		1	1	Input for car ignition lock enables delayed on/off switching of the BoxPC
Port for external Power Button	PWR01		1	1	Screw terminals for a cable for an external power button

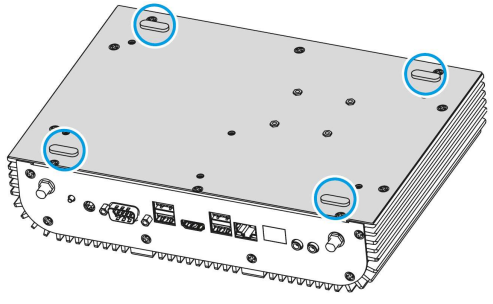
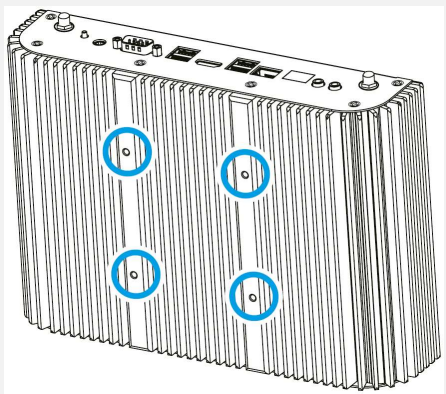
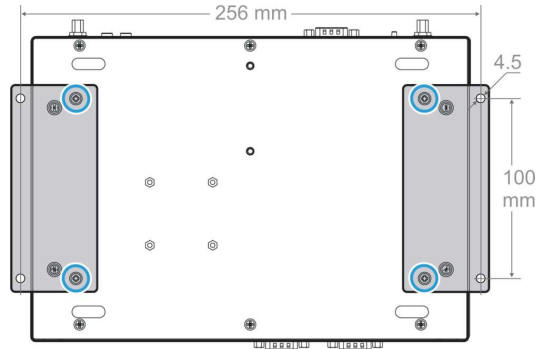
Operating Positions and Mounting

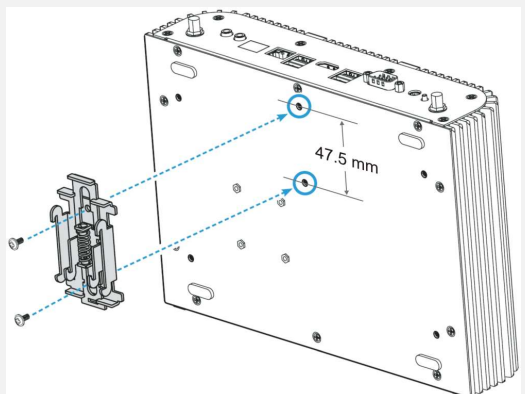
	NOTE	IMAGE
Placed horizontally	The Shuttle Box-PC series BPCWL02 can be operated in horizontal position like a desktop PC standing on its rubber feet.	
VESA-mounted	The Shuttle Box-PC series BPCWL02 features four threaded M4 holes on the upper side for a standard 75 x 75 mm VESA mount, which allows for installation on to walls or large displays. The VESA mount is not included.	
Ear-mounted	The Shuttle Box-PC series BPCWL02 features four threaded M3 holes on the bottom, which allows for it to be attached to two Ear Mount brackets (optional accessory MRS01). The Box-PC can then be affixed to a surface with four M4 screws (mounting dimension: 256 mm x 100 mm).	 
DIN-Rail-mounted	The Shuttle Box-PC series BPCWL02 features two threaded M3 holes on the bottom, which allows for installation on a standard 35 mm DIN-Rail, e.g. inside equipment racks. The matching DIN-Rail clip is an optional accessory (MDR01).	

SHUTTLE Box-PC Barebone BPCWL02-i3 – SPECIFICATIONS

Caution: Only suitably trained persons may open the barebone and install optional components!

FANLESS AND SILENT	Equipped with passive cooling, no fan noise at all Perfect to be used in noise-sensitive environments Fanless, dust-free and thus virtually maintenance-free						
24/7 NONSTOP OPERATION	This device is approved for 24/7 permanent operation. Requirement: Free circulation of air amongst the PC must be guaranteed.						
CHASSIS	Durable and rugged chassis made of aluminium and steel. Passive cooling system with specially designed fins to maximize heat dissipation. Dimensions: 16,9 x 24,5 x 5,7 cm (LWH) = approx. 2,7 litres Weight: 2.85 kg net (Barebone without RAM/SSD and optional expansions) IP-rating: IP30						
OPERATING POSITIONS AND MOUNTING	<p>1) Desktop: The unit can be placed horizontally to stand on its feet.</p> <p>2) VESA Mount: The unit can be affixed to a 75 mm x 75 mm VESA bracket. For this purpose, four M4x6L screws are required to be screwed into the chassis from the top.</p> <p>3) Side Brackets (MRS01): The unit can be mounted using two optional 256 mm x 100 mm ear-mount brackets. For this purpose, four M3x6L screws are required to be screwed into the chassis from the bottom.</p> <p>4) DIN-Rail (MDR01): Mounted on a standard 35 mm DIN-Rail, e.g. inside equipment racks</p> <p>Notes: VESA bracket, Ear-Mount and DIN-Rail clip are not included. Vertical mounting is permitted in any orientation.</p>						
OPERATING SYSTEM	This system is compatible with Windows 10/11 (64-bit) and Linux (64-bit).						
PROCESSOR	Shuttle BoxPC Barebone Model	Built-in Processor	Cores/Threads	Cache	Clock frequency (Turbo)	vPro Support	Intel UHD Graphics
	BPCWL02-i3	Intel Core i3-8145UE	2 / 4	4 MB	2.2–3.9 GHz	-	UHD 620, 300-1000 MHz
	BPCWL02-i5	Intel Core i5-8365UE	4 / 8	6 MB	1.6–4.1 GHz	Yes	UHD 620, 300-1050 MHz
	BPCWL02-i7	Intel Core i7-8665UE	4 / 8	8 MB	1.7–4.4 GHz	Yes	UHD 620, 300-1150 MHz
	System-on-a-chip architecture (SoC) with integrated memory and graphics controller FCBGA1528 package - directly soldered onto the mainboard Code name: Whiskey Lake-U (8th Generation Intel Core), Manufacturing process: 3rd-generation enhanced 14nm++ TDP wattage: 15 W maximum						
INTEGRATED GRAPHICS	Intel UHD Graphics 620 GPU clock frequency: 300–1000 MHz Execution Units (EUs): 24 Supports up to three independent screens: 1) HDMI 1.4 on the backpanel 2) optional HDMI 1.4, DisplayPort 1.2, DVI-I or D-Sub/VGA (DDI interface) 3) optional D-Sub/VGA (eDP interface, limitations: no PnP support)						
UEFI BIOS	Supports resume after power failure Supports Wake on LAN (WOL) Supports Power on by RTC Alarm Supports boot from M.2 SSD cards and USB devices AMI BIOS in 16 or 32 MB EEPROM with SPI interface Supports hardware monitoring and Watchdog function Supports Unified Extensible Firmware Interface (UEFI)						
INTEL vPRO/AMT (OPTIONAL)	Supports Intel® vPro™ and AMT – only in connection with Intel Core i5-8365UE or Intel Core i7-8665UE processors Intel® vPro™ is a brand name for a specific set of management and security technologies. Intel® Active Management Technology (AMT) is a subset of Intel vPro. This technology allows remote management of PCs, even in power-off mode or with non-functional operating systems. You can audit, repair and restore AMT-based platforms in a LAN. These functions can increase the uptime of desktops with lower maintenance costs. Note: Intel vPro requires appropriate software. The Intel® MEBX configuration user interface can be accessed after pressing CTRL-P at the beginning of the boot process. Only the Intel i219 LAN port (yellow color) supports the Intel vPro® function.						
TPM MODULE	Hardware Trusted Platform Module (Infineon SLB9670VQ2 TPM 2.0)						

	Power Adapter	Operating Temperature	Output Wattage	AC Input	DC Output	AC Cable
POWER ADAPTER [1]	Supplied model	0 to +40°C	Max. 90 W	100-240V, 50/60Hz	19V, max. 4.74A	Schuko to IEC 60320 C5
	PA1501 (optional)	-20 to +60°C	Max. 150 W (95W at 60°C)	90-260V, 50/60Hz	19V, max. 7.89A	Schuko to IEC 60320 C13
<p>DC Connector: 5.5/2.5 mm (outer/inner diameter) AC mains cable: 3 pins, ca. 1.8 m length, with C5/C6 coupler (called "Mickey Mouse" or "Clover-leaf") for the power adapter and CEE-7/7 plug with earth-contact (type E+F) for the power outlet Note: The DC input voltage range can optionally be extended to support 9-36 V.</p>						
MEMORY SUPPORT [1]	<p>2x SO-DIMM slot with 260 pins Supports DDR4-2400 (PC4-19200) SDRAM at 1.2 V Supports Dual Channel mode Supports a maximum of 32 GB per DIMM, maximum total size: 64 GB Supports two unbuffered DIMM modules (no ECC or registered)</p>					
M.2 SLOT FOR SSDs [1]	<p>The M.2 2280 M slot provides the following interfaces: - PCI-Express Gen. 3.0 X4 - SATA v3.0 (max. 6 Gbps) It supports M.2 cards with a width of 22 mm and a length of 60 or 80 mm (type 2260, 2280). Supports M.2 SATA SSDs (with B+M key) and M.2 PCIe NVMe SSDs (with M key) with auto detect</p>					
AUDIO	<p>Audio Realtek® ALC662 or ALC888S High-Definition Audio Two analog audio connectors (3.5 mm) on the back panel: 1) 2 channel line out (headphones) 2) microphone input Digital multi-channel audio output: via HDMI and optional DisplayPort</p>					
DUAL GIGABIT LAN	<p>Dual network with two RJ45 ports Used network chips: 1) Intel i211 Ethernet Controller with MAC, PHY and PCIe interface [3] 2) Intel i219LM PHY connected to the MAC of the processor Supports 10 / 100 / 1000 MBit/s operation Supports WAKE ON LAN (WOL) Supports network boot by Preboot eXecution Environment (PXE)</p>					
BACK PANEL CONNECTORS	<p>Power Button HDMI 1.4 4x USB 3.2 Gen 1 Type A (max. 5 Gbps) 2x Intel Gigabit LAN (RJ45, i211/i219LM) [3] Serial COM port (RS232) Microphone input (3.5 mm) Audio Line-out / Headphones (3.5 mm) DC-input connector for external power adapter (2.5 / 5.5 mm)</p>					
OPTIONAL FRONT PANEL CONNECTORS	<p>The front panel is subdivided into four sections to support <u>optional</u> expansion kits with daughter boards in order to add I/O ports. Caution: Only suitably trained persons may open the barebone and install optional components! 1) second graphics port: HDMI 1.4 (DHD01), DisplayPort 1.2 (DDP01), DVI-I (DDV01) or D-Sub/VGA (DVG01) 2) third graphics port: D-Sub/VGA 3) one COM port RS232 (CRS01) 4) two COM ports RS232/RS422/RS485 - occupies two sections (CSD01) 5) 4x USB 2.0 - can be installed twice (Note: USB 2.0 ports allow up to 500mA/2.5W power output, but if only low power devices like mouse/keyboard are connected, then up to 4 USB kits can be used) (USB01) 6) 4x LAN ports with 2.5 Gbps transfer speed (IDL01) 7) up to four Digital I/O expansion kits, each with 4x Input and 4x Output (DIO11) [2] 8) Input for car ignition lock enables delayed on/off switching of the BoxPC (DIO11) 9) LTE kit with two external Antennas (LTE01). Not included: LTE card in M.2-3042 format (e.g. Huawei ME906S, Sierra EM7455, Quectel EMO6E) and Nano-SIM card. 10) Terminal screws to connect a cable for an external Power Button (PWR01)</p>					
FURTHER OPTIONAL ACCESSORIES	<p>1) Wide range DC-input 9~36 V, instead of only 19 V (VOL01) 2) Ear-mount brackets, mounting dimensions: 256 mm x 100 mm (MRS01) 3) DIN-Rail clip (special clip has holes without thread) (MDR01) 4) WLAN module with two external antennas (WMAX2001+CWL01) 5) One LAN port in the backpanel can be upgraded to 2.5 Gb/s (IDL11) [3]</p>					

ENVIRONMENTAL SPECIFICATIONS	Option	Operating temperature	Relative humidity
	Standard	0 to +40°C	20-80 %, non-condensing
	Industrial	-20 to +60°C	20-80 %, non-condensing

Notice the footnote [1]

CONFORMITY AND CERTIFICATIONS	EMI: CE, FCC Class A, VCCI, RCM, BSMI
	Safety: CB, cTUVus, BSMI
	Other: RoHS, ErP, CEC

This device is classed as a technical information equipment (ITE) in Class A, Class A is for product used in commercial and industrial areas. The CE-mark approves the conformity by the EU directives:

- (1) 2014/30/EU relating to electromagnetic compatibility (EMC),
- (2) 2014/35/EU relating to Electrical Equipment designed for use within certain voltage limits (LVD),
- (3) 2009/125/EC relating to eco design requirements for energy-related products (ErP)

[1] for safe operation in the **extended operating temperature range (-20 to +60°C)**, the optional 150W power supply **PA1501** is required and industrial-grade RAM/SSD components with an operating temperature range of -40 ... +85 °C are also required

[2] The DIO expansion kit comes with the appropriate plug connector included. The digital inputs recognize "Low" at 0-3 Volt and "High" at 5-30 Volt (or open). The digital outputs can handle 0-30V (open collector) with up to 30 mA current.

[3] LAN-Port-Upgrade

The yellow LAN port on the back panel (Intel i211 chip) with max. 1 Gbps speed can optionally be upgraded to 2.5 Gbps speed (Intel i226 chip) with the accessory **IDL11**.